

DATA SHEET

PCD8544

48 × 84 pixels matrix LCD
controller/driver

Product specification
File under Integrated Circuits, IC17

1999 Apr 12

48 × 84 pixels matrix LCD controller/driver**PCD8544**

CONTENTS			
1	FEATURES	8	INSTRUCTIONS
2	GENERAL DESCRIPTION	8.1	Initialization
3	APPLICATIONS	8.2	Reset function
4	ORDERING INFORMATION	8.3	Function set
5	BLOCK DIAGRAM	8.3.1	Bit PD
6	PINNING	8.3.2	Bit V
6.1	Pin functions	8.3.3	Bit H
6.1.1	R0 to R47 row driver outputs	8.4	Display control
6.1.2	C0 to C83 column driver outputs	8.4.1	Bits D and E
6.1.3	V _{SS1} , V _{SS2} : negative power supply rails	8.5	Set Y address of RAM
6.1.4	V _{DD1} , V _{DD2} : positive power supply rails	8.6	Set X address of RAM
6.1.5	V _{LCD1} , V _{LCD2} : LCD power supply	8.7	Temperature control
6.1.6	T1, T2, T3 and T4: test pads	8.8	Bias value
6.1.7	SDIN: serial data line	8.9	Set V _{OP} value
6.1.8	SCLK: serial clock line	9	LIMITING VALUES
6.1.9	D/C: mode select	10	HANDLING
6.1.10	SCE: chip enable	11	DC CHARACTERISTICS
6.1.11	OSC: oscillator	12	AC CHARACTERISTICS
6.1.12	RES: reset	12.1	Serial interface
7	FUNCTIONAL DESCRIPTION	12.2	Reset
7.1	Oscillator	13	APPLICATION INFORMATION
7.2	Address Counter (AC)	14	BONDING PAD LOCATIONS
7.3	Display Data RAM (DDRAM)	14.1	Bonding pad information
7.4	Timing generator	14.2	Bonding pad location
7.5	Display address counter	15	TRAY INFORMATION
7.6	LCD row and column drivers	16	DEFINITIONS
7.7	Addressing	17	LIFE SUPPORT APPLICATIONS
7.7.1	Data structure		
7.8	Temperature compensation		

SKYTECH
ELECTRONIC

48 × 84 pixels matrix LCD controller/driver

PCD8544

1 FEATURES

- Single chip LCD controller/driver
- 48 row, 84 column outputs
- Display data RAM 48 × 84 bits
- On-chip:
 - Generation of LCD supply voltage (external supply also possible)
 - Generation of intermediate LCD bias voltages
 - Oscillator requires no external components (external clock also possible).
- External $\overline{\text{RES}}$ (reset) input pin
- Serial interface maximum 4.0 Mbits/s
- CMOS compatible inputs
- Mux rate: 48
- Logic supply voltage range V_{DD} to V_{SS} : 2.7 to 3.3 V
- Display supply voltage range V_{LCD} to V_{SS}
 - 6.0 to 8.5 V with LCD voltage internally generated (voltage generator enabled)
 - 6.0 to 9.0 V with LCD voltage externally supplied (voltage generator switched-off).
- Low power consumption, suitable for battery operated systems
- Temperature compensation of V_{LCD}
- Temperature range: -25 to +70 °C.

2 GENERAL DESCRIPTION

The PCD8544 is a low power CMOS LCD controller/driver, designed to drive a graphic display of 48 rows and 84 columns. All necessary functions for the display are provided in a single chip, including on-chip generation of LCD supply and bias voltages, resulting in a minimum of external components and low power consumption.

The PCD8544 interfaces to microcontrollers through a serial bus interface.

The PCD8544 is manufactured in n-well CMOS technology.

3 APPLICATIONS

- Telecommunications equipment.

4 ORDERING INFORMATION

TYPE NUMBER	PACKAGE		
	NAME	DESCRIPTION	VERSION
PCD8544U	-	chip with bumps in tray; 168 bonding pads + 4 dummy pads	-



48 × 84 pixels matrix LCD controller/driver

PCD8544

5 BLOCK DIAGRAM

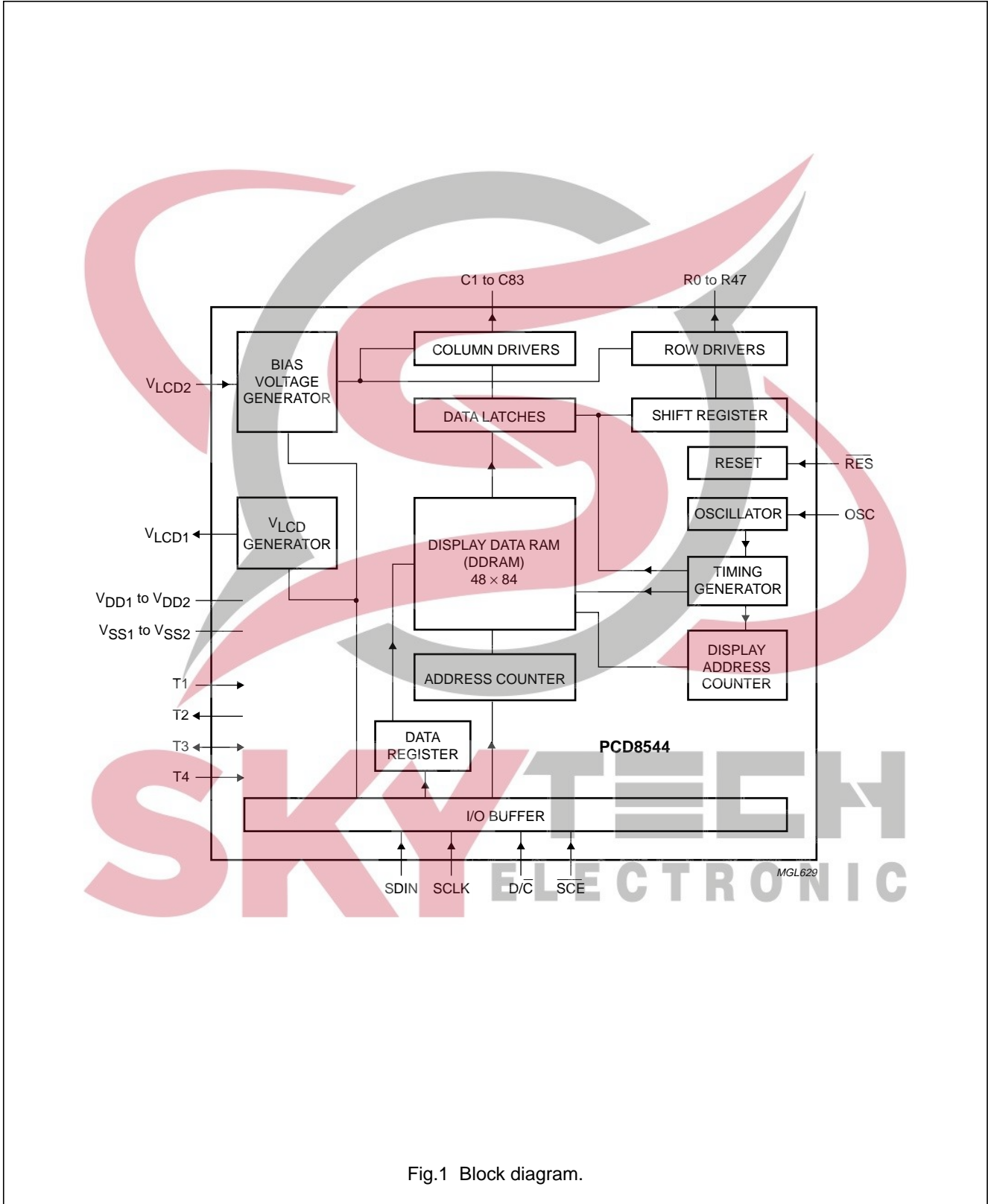

Fig.1 Block diagram.

48 × 84 pixels matrix LCD controller/driver

PCD8544

6 PINNING

SYMBOL	DESCRIPTION
R0 to R47	LCD row driver outputs
C0 to C83	LCD column driver outputs
V _{SS1} , V _{SS2}	ground
V _{DD1} , V _{DD2}	supply voltage
V _{LCD1} , V _{LCD2}	LCD supply voltage
T1	test 1 input
T2	test 2 output
T3	test 3 input/output
T4	test 4 input
SDIN	serial data input
SCLK	serial clock input
D/C	data/command
SCE	chip enable
OSC	oscillator
RES	external reset input
dummy1, 2, 3, 4	not connected

Note

1. For further details, see Fig.18 and Table 7.

6.1 Pin functions

6.1.1 R0 to R47 ROW DRIVER OUTPUTS

These pads output the row signals.

6.1.2 C0 to C83 COLUMN DRIVER OUTPUTS

These pads output the column signals.

6.1.3 V_{SS1}, V_{SS2}: NEGATIVE POWER SUPPLY RAILS

Supply rails V_{SS1} and V_{SS2} must be connected together.

6.1.4 V_{DD1}, V_{DD2}: POSITIVE POWER SUPPLY RAILS

Supply rails V_{DD1} and V_{DD2} must be connected together.

6.1.5 V_{LCD1}, V_{LCD2}: LCD POWER SUPPLY

Positive power supply for the liquid crystal display. Supply rails V_{LCD1} and V_{LCD2} must be connected together.

6.1.6 T1, T2, T3 AND T4: TEST PADS

T1, T3 and T4 must be connected to V_{SS}, T2 is to be left open. Not accessible to user.

6.1.7 SDIN: SERIAL DATA LINE

Input for the data line.

6.1.8 SCLK: SERIAL CLOCK LINE

Input for the clock signal: 0.0 to 4.0 Mbits/s.

6.1.9 D/C: MODE SELECT

Input to select either command/address or data input.

6.1.10 SCE: CHIP ENABLE

The enable pin allows data to be clocked in. The signal is active LOW.

6.1.11 OSC: OSCILLATOR

When the on-chip oscillator is used, this input must be connected to V_{DD}. An external clock signal, if used, is connected to this input. If the oscillator and external clock are both inhibited by connecting the OSC pin to V_{SS}, the display is not clocked and may be left in a DC state.

To avoid this, the chip should always be put into Power-down mode before stopping the clock.

6.1.12 RES: RESET

This signal will reset the device and must be applied to properly initialize the chip. The signal is active LOW.

48 × 84 pixels matrix LCD controller/driver**PCD8544**

7 FUNCTIONAL DESCRIPTION**7.1 Oscillator**

The on-chip oscillator provides the clock signal for the display system. No external components are required and the OSC input must be connected to V_{DD} . An external clock signal, if used, is connected to this input.

7.2 Address Counter (AC)

The address counter assigns addresses to the display data RAM for writing. The X-address X_6 to X_0 and the Y-address Y_2 to Y_0 are set separately. After a write operation, the address counter is automatically incremented by 1, according to the V flag.

7.3 Display Data RAM (DDRAM)

The DDRAM is a 48×84 bit static RAM which stores the display data. The RAM is divided into six banks of 84 bytes ($6 \times 8 \times 84$ bits). During RAM access, data is transferred to the RAM through the serial interface. There is a direct correspondence between the X-address and the column output number.

7.4 Timing generator

The timing generator produces the various signals required to drive the internal circuits. Internal chip operation is not affected by operations on the data buses.

7.5 Display address counter

The display is generated by continuously shifting rows of RAM data to the dot matrix LCD through the column outputs. The display status (all dots on/off and normal/inverse video) is set by bits E and D in the 'display control' command.

7.6 LCD row and column drivers

The PCD8544 contains 48 row and 84 column drivers, which connect the appropriate LCD bias voltages in sequence to the display in accordance with the data to be displayed. Figure 2 shows typical waveforms. Unused outputs should be left unconnected.



SKYTECH
ELECTRONIC

48 × 84 pixels matrix LCD controller/driver

PCD8544

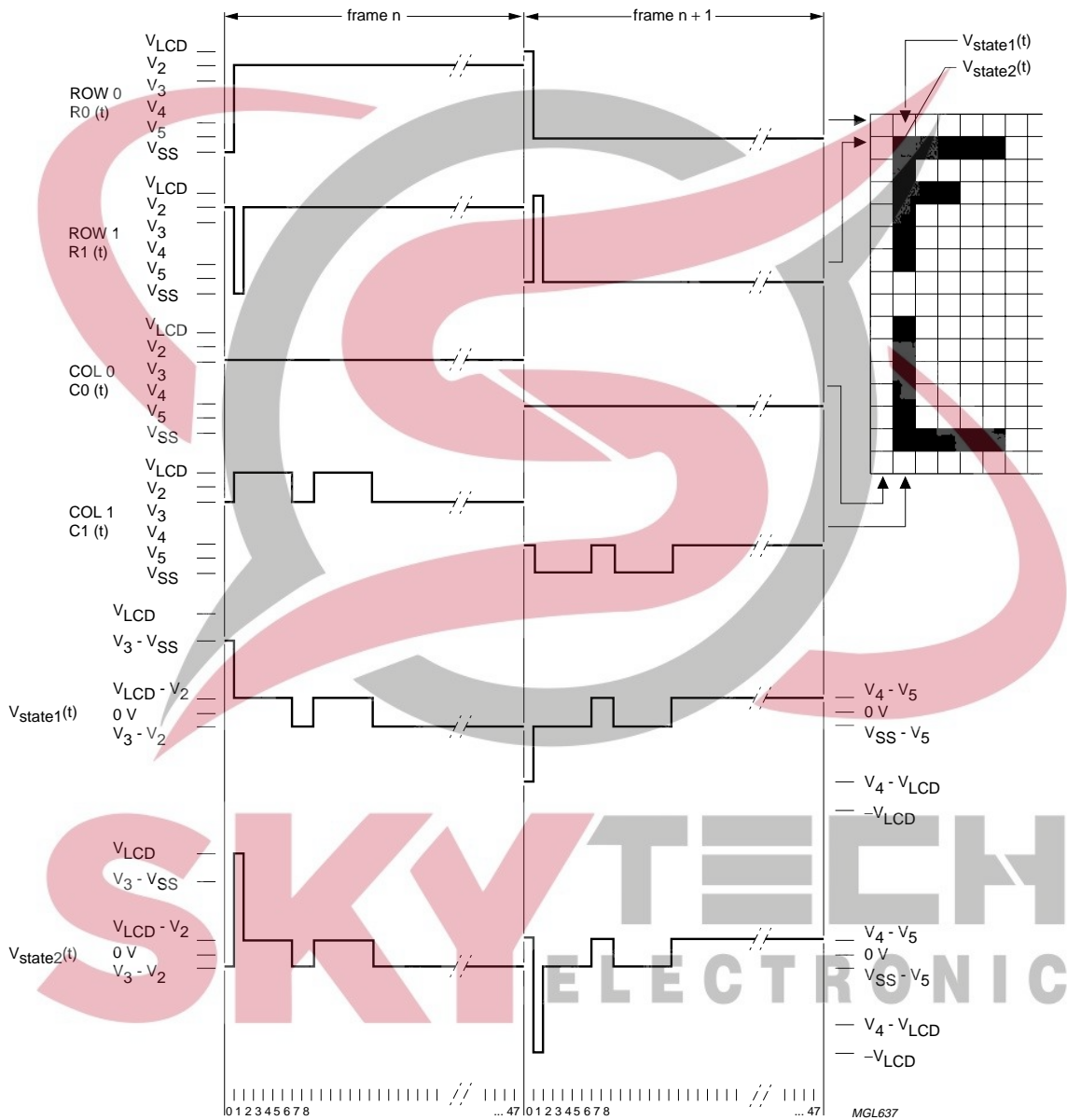

$V_{state1}(t) = C1(t) - R0(t).$
 $V_{state2}(t) = C1(t) - R1(t).$

Fig.2 Typical LCD driver waveforms.

48 × 84 pixels matrix LCD controller/driver

PCD8544

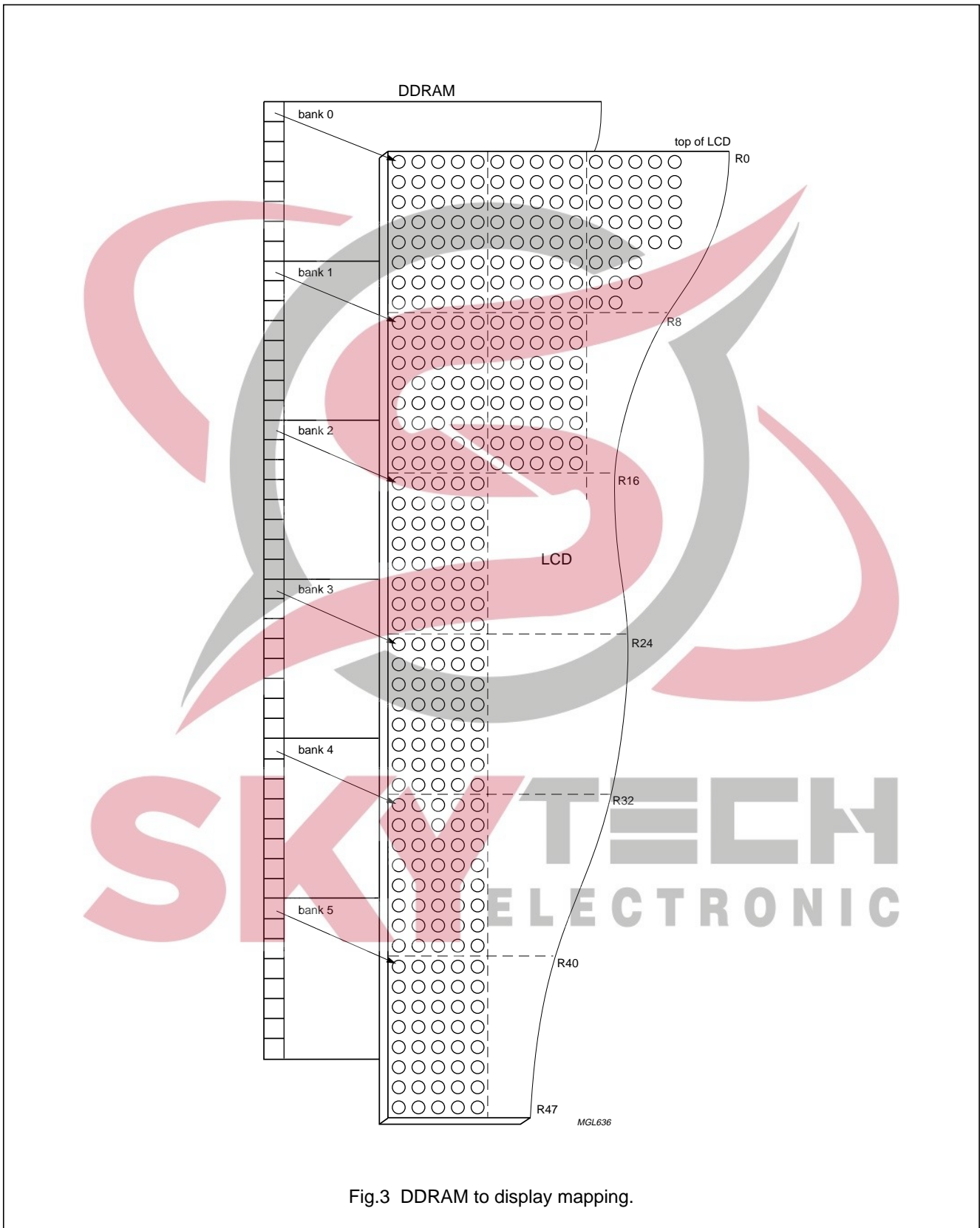

Fig.3 DDRAM to display mapping.

48 × 84 pixels matrix LCD controller/driver

PCD8544

7.7 Addressing

Data is downloaded in bytes into the 48 by 84 bits RAM data display matrix of PCD8544, as indicated in Figs. 3, 4, 5 and 6. The columns are addressed by the address pointer. The address ranges are: X 0 to 83 (1010011), Y 0 to 5 (101). Addresses outside these ranges are not allowed. In the vertical addressing mode ($V = 1$), the Y address increments after each byte (see

Fig.5). After the last Y address ($Y = 5$), Y wraps around to 0 and X increments to address the next column. In the horizontal addressing mode ($V = 0$), the X address increments after each byte (see Fig.6). After the last X address ($X = 83$), X wraps around to 0 and Y increments to address the next row. After the very last address ($X = 83$ and $Y = 5$), the address pointers wrap around to address ($X = 0$ and $Y = 0$).

7.7.1 DATA STRUCTURE

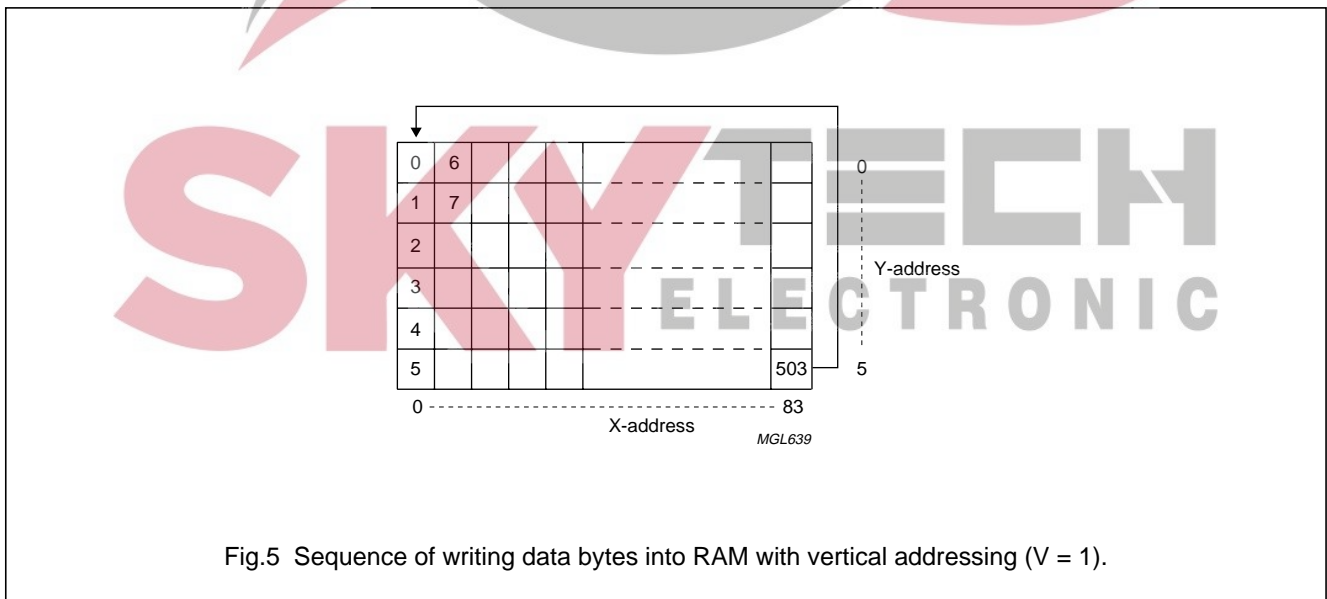
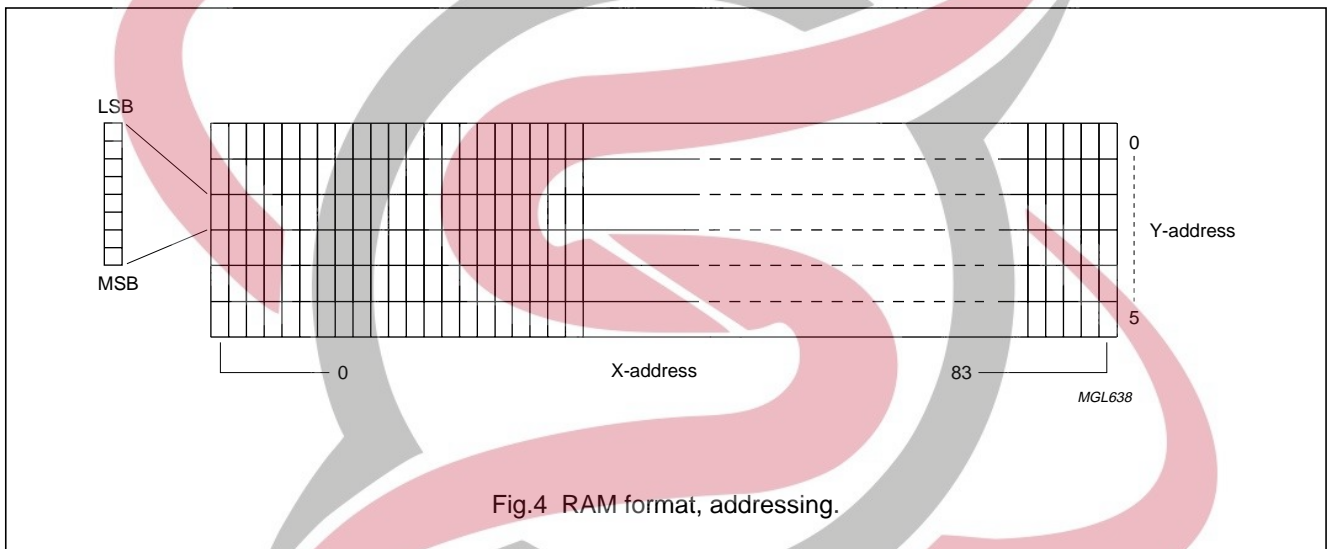

48 × 84 pixels matrix LCD controller/driver

PCD8544

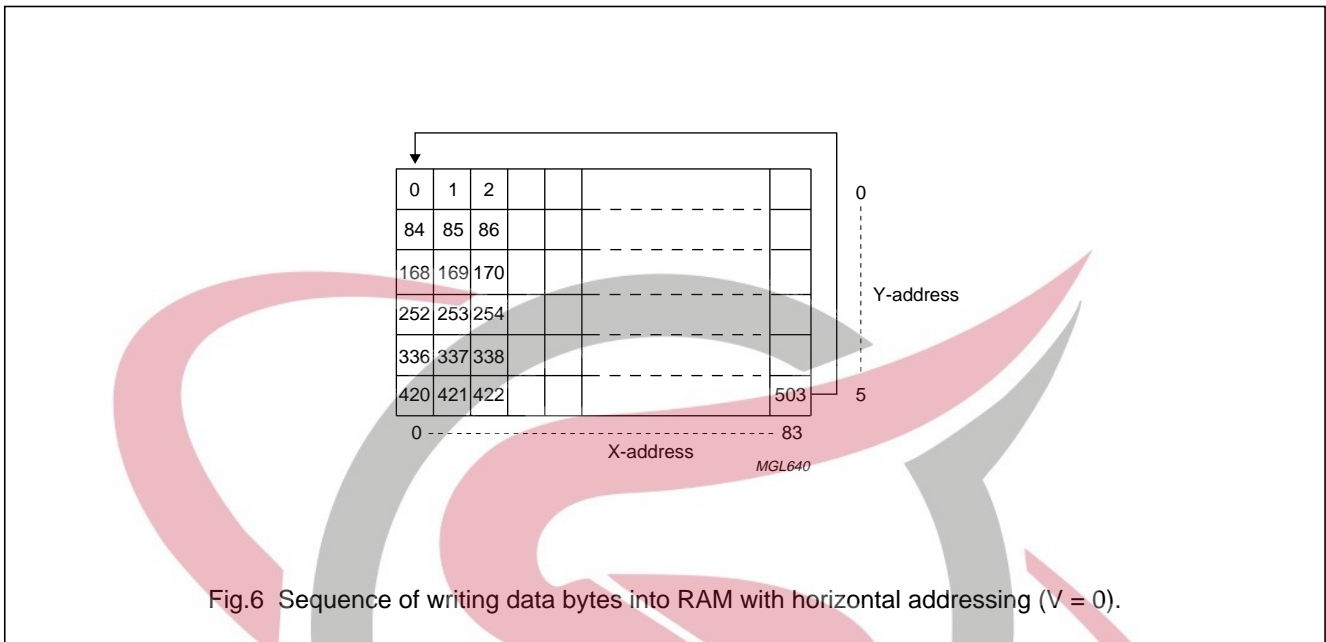

7.8 Temperature compensation

Due to the temperature dependency of the liquid crystals' viscosity, the LCD controlling voltage V_{LCD} must be increased at lower temperatures to maintain optimum

contrast. Figure 7 shows V_{LCD} for high multiplex rates. In the PCD8544, the temperature coefficient of V_{LCD} , can be selected from four values (see Table 2) by setting bits TC_1 and TC_0 .

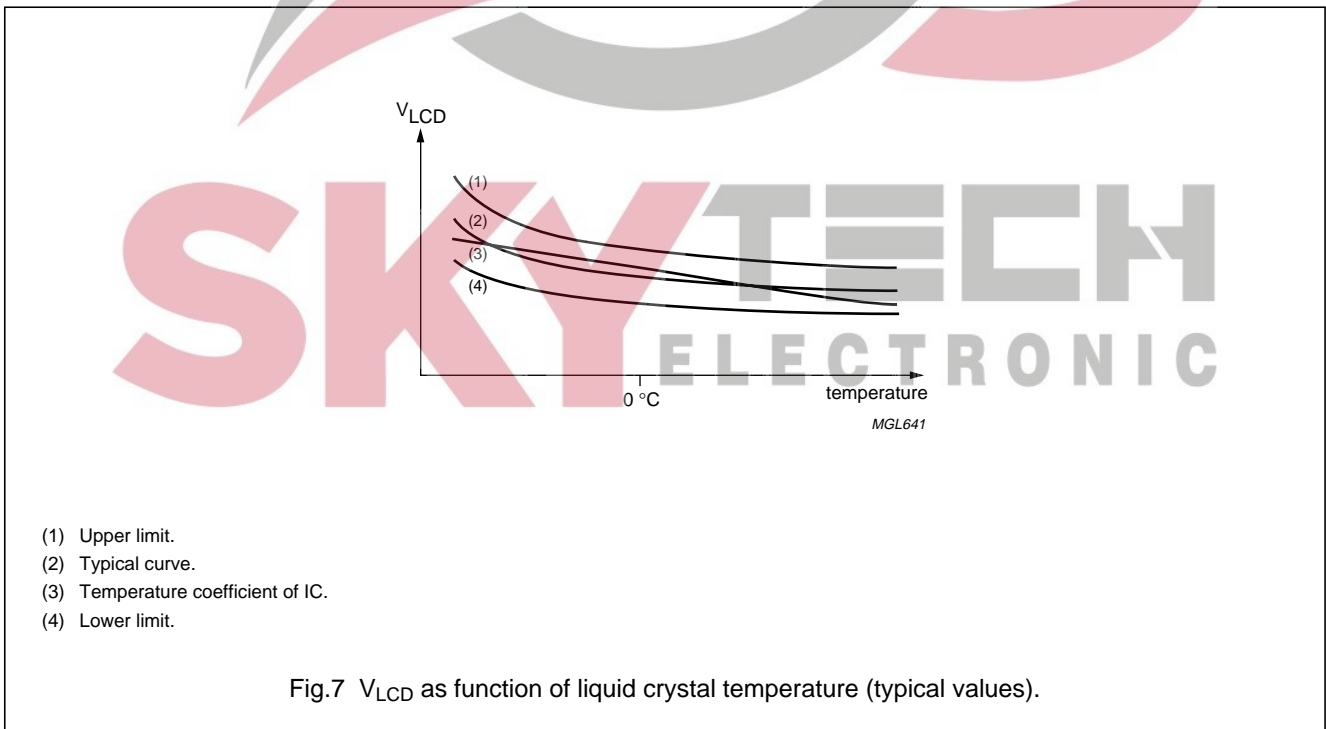

48 × 84 pixels matrix LCD controller/driver

PCD8544

8 INSTRUCTIONS

The instruction format is divided into two modes: If $\overline{D/\overline{C}}$ (mode select) is set LOW, the current byte is interpreted as command byte (see Table 1). Figure 8 shows an example of a serial data stream for initializing the chip. If $\overline{D/\overline{C}}$ is set HIGH, the following bytes are stored in the display data RAM. After every data byte, the address counter is incremented automatically.

The level of the $\overline{D/\overline{C}}$ signal is read during the last bit of data byte.

Each instruction can be sent in any order to the PCD8544. The MSB of a byte is transmitted first. Figure 9 shows one possible command stream, used to set up the LCD driver.

The serial interface is initialized when \overline{SCE} is HIGH. In this state, SCLK clock pulses have no effect and no power is consumed by the serial interface. A negative edge on \overline{SCE} enables the serial interface and indicates the start of a data transmission.

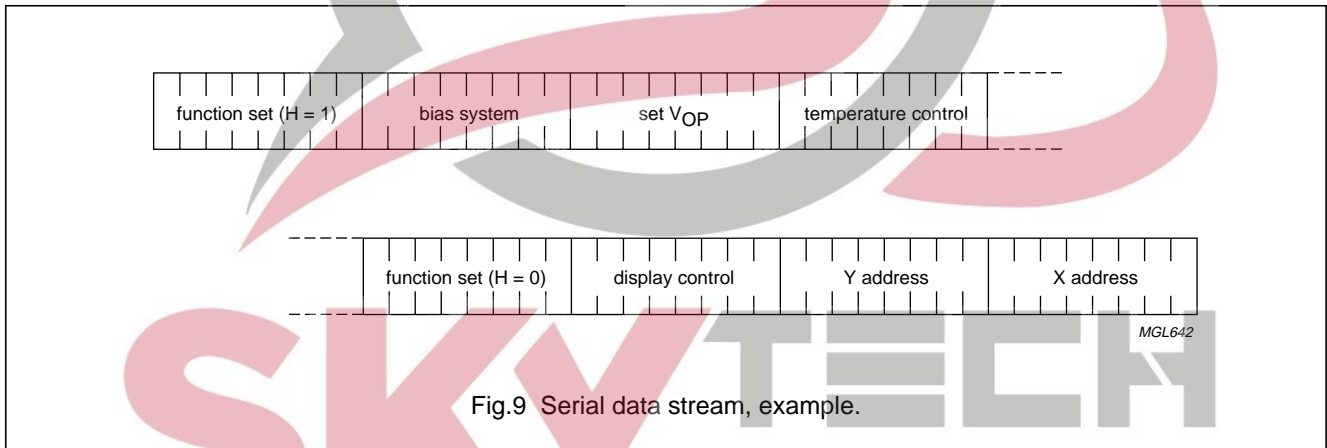
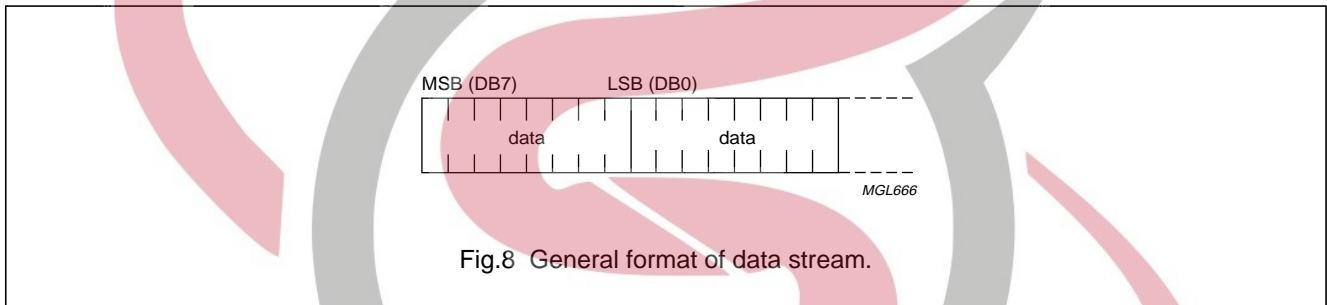

Figures 10 and 11 show the serial bus protocol.

- When \overline{SCE} is HIGH, SCLK clock signals are ignored; during the HIGH time of \overline{SCE} , the serial interface is initialized (see Fig.12)
- SDIN is sampled at the positive edge of SCLK
- $\overline{D/\overline{C}}$ indicates whether the byte is a command ($\overline{D/\overline{C}} = 0$) or RAM data ($\overline{D/\overline{C}} = 1$); it is read with the eighth SCLK pulse
- If \overline{SCE} stays LOW after the last bit of a command/data byte, the serial interface expects bit 7 of the next byte at the next positive edge of SCLK (see Fig.12)
- A reset pulse with \overline{RES} interrupts the transmission. No data is written into the RAM. The registers are cleared. If \overline{SCE} is LOW after the positive edge of \overline{RES} , the serial interface is ready to receive bit 7 of a command/data byte (see Fig.13).

48 × 84 pixels matrix LCD controller/driver

PCD8544

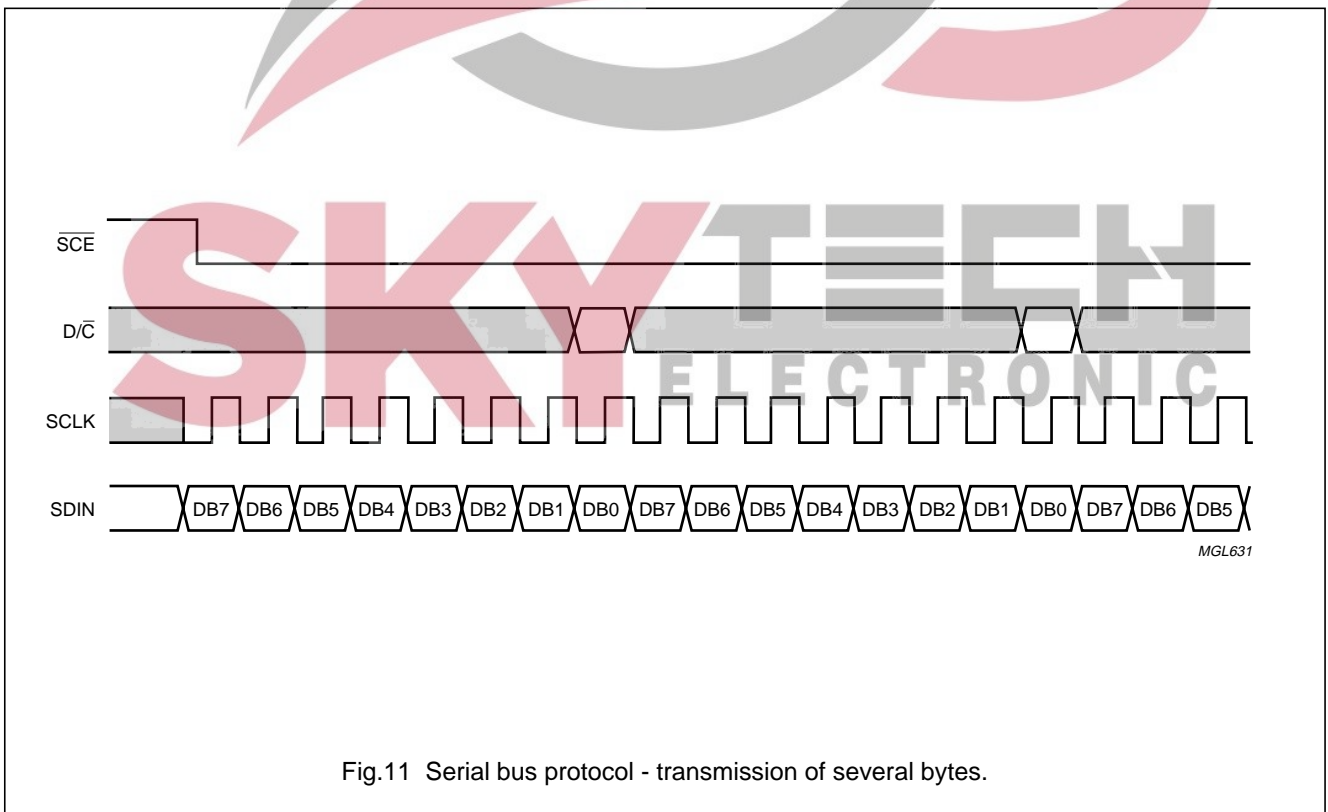
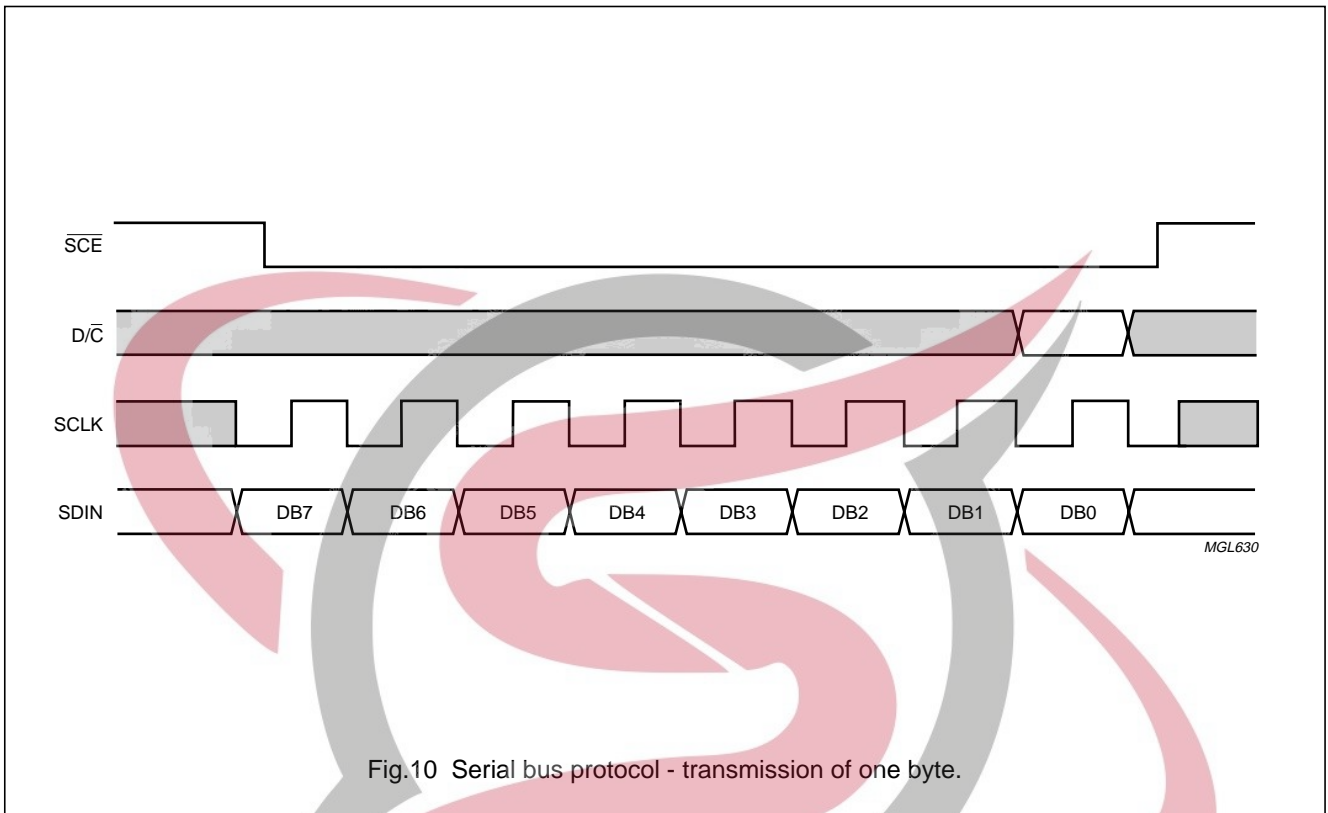

48 × 84 pixels matrix LCD controller/driver

PCD8544

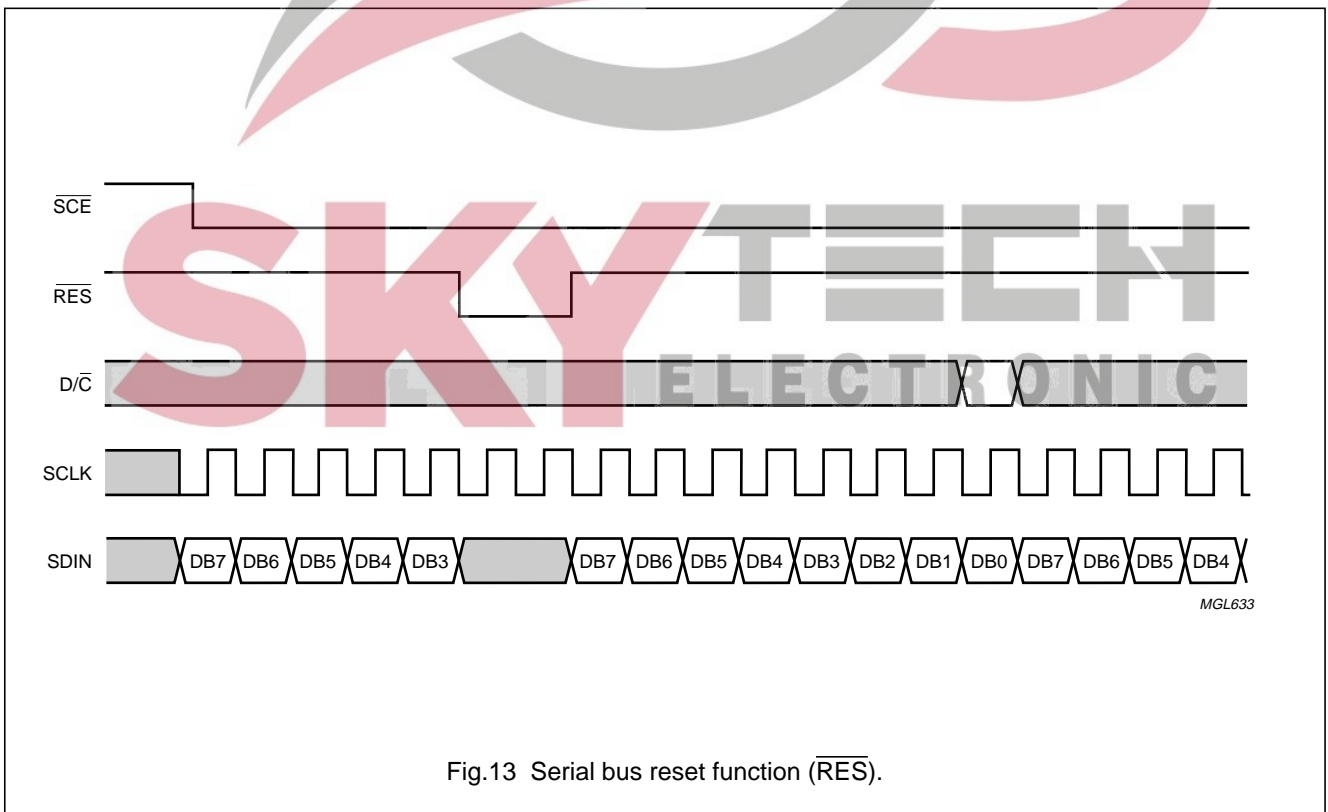
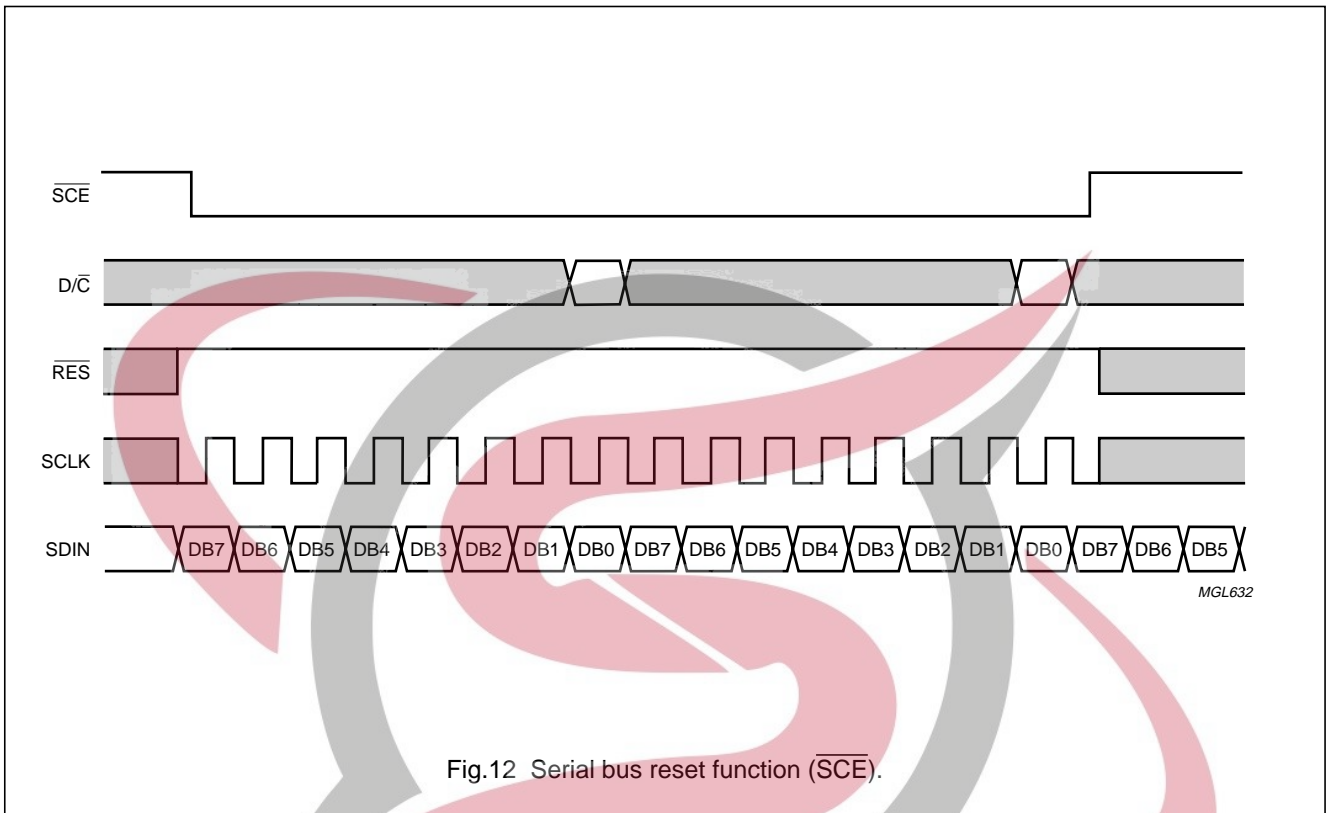

48 × 84 pixels matrix LCD controller/driver

PCD8544

Table 1 Instruction set

INSTRUCTION	D/C	COMMAND BYTE								DESCRIPTION	
		DB7	DB6	DB5	DB4	DB3	DB2	DB1	DB0		
(H = 0 or 1)											
NOP	0	0	0	0	0	0	0	0	0	0	no operation
Function set	0	0	0	1	0	0	PD	V	H		power down control; entry mode; extended instruction set control (H)
Write data	1	D ₇	D ₆	D ₅	D ₄	D ₃	D ₂	D ₁	D ₀		writes data to display RAM
(H = 0)											
Reserved	0	0	0	0	0	0	1	X	X		do not use
Display control	0	0	0	0	0	1	D	0	E		sets display configuration
Reserved	0	0	0	0	1	X	X	X	X		do not use
Set Y address of RAM	0	0	1	0	0	0	Y ₂	Y ₁	Y ₀		sets Y-address of RAM; 0 ≤ Y ≤ 5
Set X address of RAM	0	1	X ₆	X ₅	X ₄	X ₃	X ₂	X ₁	X ₀		sets X-address part of RAM; 0 ≤ X ≤ 83
(H = 1)											
Reserved	0	0	0	0	0	0	0	0	1		do not use
	0	0	0	0	0	0	0	1	X		do not use
Temperature control	0	0	0	0	0	0	1	TC ₁	TC ₀		set Temperature Coefficient (TC _x)
Reserved	0	0	0	0	0	1	X	X	X		do not use
Bias system	0	0	0	0	1	0	BS ₂	BS ₁	BS ₀		set Bias System (BS _x)
Reserved	0	0	1	X	X	X	X	X	X		do not use
Set V _{OP}	0	1	V _{OP6}	V _{OP5}	V _{OP4}	V _{OP3}	V _{OP2}	V _{OP1}	V _{OP0}		write V _{OP} to register

Table 2 Explanations of symbols in Table 1

BIT	0	1
PD	chip is active	chip is in Power-down mode
V	horizontal addressing	vertical addressing
H	use basic instruction set	use extended instruction set
D and E	00 display blank 10 normal mode 01 all display segments on 11 inverse video mode	
TC ₁ and TC ₀	00 V _{LCD} temperature coefficient 0 01 V _{LCD} temperature coefficient 1 10 V _{LCD} temperature coefficient 2 11 V _{LCD} temperature coefficient 3	

48 × 84 pixels matrix LCD controller/driver

PCD8544

8.1 Initialization

Immediately following power-on, the contents of all internal registers and of the RAM are undefined. A **RES pulse must be applied**. Attention should be paid to the possibility that the **device may be damaged** if not properly reset.

All internal registers are reset by applying an external $\overline{\text{RES}}$ pulse (active LOW) at pad 31, within the specified time. However, the RAM contents are still undefined. The state after reset is described in Section 8.2.

The $\overline{\text{RES}}$ input must be $\leq 0.3V_{\text{DD}}$ when V_{DD} reaches V_{DDmin} (or higher) within a maximum time of 100 ms after V_{DD} goes HIGH (see Fig.16).

8.2 Reset function

After reset, the LCD driver has the following state:

- Power-down mode (bit PD = 1)
- Horizontal addressing (bit V = 0) normal instruction set (bit H = 0)
- Display blank (bit E = D = 0)
- Address counter X_6 to $X_0 = 0$; Y_2 to $Y_0 = 0$
- Temperature control mode (TC_1 $\text{TC}_0 = 0$)
- Bias system (BS_2 to $\text{BS}_0 = 0$)
- V_{LCD} is equal to 0, the HV generator is switched off (V_{OP6} to $V_{\text{OP0}} = 0$)
- After power-on, the RAM contents are undefined.

8.3 Function set**8.3.1 BIT PD**

- All LCD outputs at V_{SS} (display off)
- Bias generator and V_{LCD} generator off, V_{LCD} can be disconnected
- Oscillator off (external clock possible)
- Serial bus, command, etc. function
- Before entering Power-down mode, the RAM needs to be filled with '0's to ensure the specified current consumption.

8.3.2 BIT V

When $V = 0$, the horizontal addressing is selected. The data is written into the DDRAM as shown in Fig.6. When $V = 1$, the vertical addressing is selected. The data is written into the DDRAM, as shown in Fig.5.

8.3.3 BIT H

When $H = 0$ the commands 'display control', 'set Y address' and 'set X address' can be performed; when $H = 1$, the others can be executed. The 'write data' and 'function set' commands can be executed in both cases.

8.4 Display control**8.4.1 BITS D AND E**

Bits D and E select the display mode (see Table 2).

8.5 Set Y address of RAM

Y_n defines the Y vector addressing of the display RAM.

Table 3 Y vector addressing

Y_2	Y_1	Y_0	BANK
0	0	0	0
0	0	1	1
0	1	0	2
0	1	1	3
1	0	0	4
1	0	1	5

8.6 Set X address of RAM

The X address points to the columns. The range of X is 0 to 83 (53H).

8.7 Temperature control

The temperature coefficient of V_{LCD} is selected by bits TC_1 and TC_0 .

8.8 Bias value

The bias voltage levels are set in the ratio of $R - R - nR - R - R$, giving a $1/(n + 4)$ bias system. Different multiplex rates require different factors n (see Table 4). This is programmed by BS_2 to BS_0 . For Mux 1 : 48, the optimum bias value n , resulting in 1/8 bias, is given by:

$$n = \sqrt{48} - 3 = 3.928 = 4 \quad (1)$$

48 × 84 pixels matrix LCD controller/driver

PCD8544

Table 4 Programming the required bias system

BS ₂	BS ₁	BS ₀	n	RECOMMENDED MUX RATE
0	0	0	7	1 : 100
0	0	1	6	1 : 80
0	1	0	5	1 : 65/1 : 65
0	1	1	4	1 : 48
1	0	0	3	1 : 40/1 : 34
1	0	1	2	1 : 24
1	1	0	1	1 : 18/1 : 16
1	1	1	0	1 : 10/1 : 9/1 : 8

Table 5 LCD bias voltage

SYMBOL	BIAS VOLTAGES	BIAS VOLTAGE FOR 1/8 BIAS
V1	V _{LCD}	V _{LCD}
V2	(n + 3)/(n + 4)	7/8 × V _{LCD}
V3	(n + 2)/(n + 4)	6/8 × V _{LCD}
V4	2/(n + 4)	2/8 × V _{LCD}
V5	1/(n + 4)	1/8 × V _{LCD}
V6	V _{SS}	V _{SS}

8.9 Set V_{OP} value

The operation voltage V_{LCD} can be set by software. The values are dependent on the liquid crystal selected. V_{LCD} = a + (V_{OP6} to V_{OP0}) × b [V]. In the PCD8544, a = 3.06 and b = 0.06 giving a program range of 3.00 to 10.68 at room temperature.

Note that the charge pump is turned off if V_{OP6} to V_{OP0} is set to zero.

For Mux 1 : 48, the optimum operation voltage of the liquid can be calculated as:

$$V_{LCD} = \frac{1 + \sqrt{48}}{\sqrt{2 \cdot \left(1 - \frac{1}{\sqrt{48}}\right)}} \cdot V_{th} = 6.06 \cdot V_{th} \tag{2}$$

where V_{th} is the threshold voltage of the liquid crystal material used.

Caution, as V_{OP} increases with lower temperatures, care must be taken not to set a V_{OP} that will exceed the maximum of 8.5 V when operating at -25 °C.

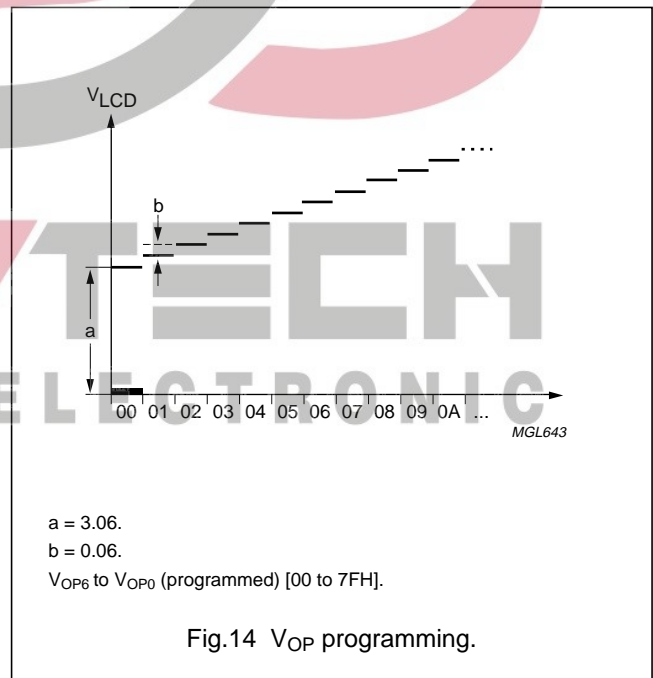

48 × 84 pixels matrix LCD controller/driver

PCD8544

9 LIMITING VALUES

In accordance with the Absolute Maximum Rating System (IEC 134); see notes 1 and 2.

SYMBOL	PARAMETER	CONDITIONS	MIN.	MAX.	UNIT
V_{DD}	supply voltage	note 3	-0.5	+7	V
V_{LCD}	supply voltage LCD	note 4	-0.5	+10	V
V_i	all input voltages		-0.5	$V_{DD} + 0.5$	V
I_{SS}	ground supply current		-50	+50	mA
I_i, I_o	DC input or output current		-10	+10	mA
P_{tot}	total power dissipation		-	300	mW
P_o	power dissipation per output		-	30	mW
T_{amb}	operating ambient temperature		-25	+70	°C
T_j	operating junction temperature		-65	+150	°C
T_{stg}	storage temperature		-65	+150	°C

Notes

1. Stresses above those listed under limiting values may cause permanent damage to the device.
2. Parameters are valid over operating temperature range unless otherwise specified. All voltages are with respect to V_{SS} unless otherwise noted.
3. With external LCD supply voltage externally supplied (voltage generator disabled), $V_{DDmax} = 5$ V if LCD supply voltage is internally generated (voltage generator enabled).
4. When setting V_{LCD} by software, take care not to set a V_{OP} that will exceed the maximum of 8.5 V when operating at -25 °C, see Caution in Section 8.9.

10 HANDLING

Inputs and outputs are protected against electrostatic discharge in normal handling. However, to be totally safe, it is desirable to take normal precautions appropriate to handling MOS devices (see "Handling MOS devices").



The logo for SKYTECH ELECTRONIC features the word "SKY" in a large, bold, pink font, followed by "TECH" in a smaller, grey, blocky font. Below "TECH" is the word "ELECTRONIC" in a smaller, grey, blocky font.

48 × 84 pixels matrix LCD controller/driver

PCD8544

11 DC CHARACTERISTICS

$V_{DD} = 2.7$ to 3.3 V; $V_{SS} = 0$ V; $V_{LCD} = 6.0$ to 9.0 V; $T_{amb} = -25$ to $+70$ °C; unless otherwise specified.

SYMBOL	PARAMETER	CONDITIONS	MIN.	TYP.	MAX.	UNIT
V_{DD1}	supply voltage 1	LCD voltage externally supplied (voltage generator disabled)	2.7	–	3.3	V
V_{DD2}	supply voltage 2	LCD voltage internally generated (voltage generator enabled)	2.7	–	3.3	V
V_{LCD1}	LCD supply voltage	LCD voltage externally supplied (voltage generator disabled)	6.0	–	9.0	V
V_{LCD2}	LCD supply voltage	LCD voltage internally generated (voltage generator enabled); note 1	6.0	–	8.5	V
I_{DD1}	supply current 1 (normal mode) for internal V_{LCD}	$V_{DD} = 2.85$ V; $V_{LCD} = 7.0$ V; $f_{SCLK} = 0$; $T_{amb} = 25$ °C; display load = 10 μ A; note 2	–	240	300	μ A
I_{DD2}	supply current 2 (normal mode) for internal V_{LCD}	$V_{DD} = 2.70$ V; $V_{LCD} = 7.0$ V; $f_{SCLK} = 0$; $T_{amb} = 25$ °C; display load = 10 μ A; note 2	–	–	320	μ A
I_{DD3}	supply current 3 (Power-down mode)	with internal or external LCD supply voltage; note 3	–	1.5	–	μ A
I_{DD4}	supply current external V_{LCD}	$V_{DD} = 2.85$ V; $V_{LCD} = 9.0$ V; $f_{SCLK} = 0$; notes 2 and 4	–	25	–	μ A
I_{LCD}	supply current external V_{LCD}	$V_{DD} = 2.7$ V; $V_{LCD} = 7.0$ V; $f_{SCLK} = 0$; $T = 25$ °C; display load = 10 μ A; notes 2 and 4	–	42	–	μ A
Logic						
V_{IL}	LOW level input voltage		V_{SS}	–	$0.3V_{DD}$	V
V_{IH}	HIGH level input voltage		$0.7V_{DD}$	–	V_{DD}	V
I_L	leakage current	$V_I = V_{DD}$ or V_{SS}	–1	–	+1	μ A
Column and row outputs						
$R_{O(C)}$	column output resistance C0 to C83		–	12	20	k Ω
$R_{O(R)}$	row output resistance R0 to R47		–	12	20	k Ω
$V_{bias(tol)}$	bias voltage tolerance on C0 to C83 and R0 to R47		–100	0	+100	mV

48 × 84 pixels matrix LCD controller/driver

PCD8544

SYMBOL	PARAMETER	CONDITIONS	MIN.	TYP.	MAX.	UNIT
LCD supply voltage generator						
V _{LCD}	V _{LCD} tolerance internally generated	V _{DD} = 2.85 V; V _{LCD} = 7.0 V; f _{SCLK} = 0; display load = 10 μA; note 5	–	0	300	mV
TC0	V _{LCD} temperature coefficient 0	V _{DD} = 2.85 V; V _{LCD} = 7.0 V; f _{SCLK} = 0; display load = 10 μA	–	1	–	mV/K
TC1	V _{LCD} temperature coefficient 1	V _{DD} = 2.85 V; V _{LCD} = 7.0 V; f _{SCLK} = 0; display load = 10 μA	–	9	–	mV/K
TC2	V _{LCD} temperature coefficient 2	V _{DD} = 2.85 V; V _{LCD} = 7.0 V; f _{SCLK} = 0; display load = 10 μA	–	17	–	mV/K
TC3	V _{LCD} temperature coefficient 3	V _{DD} = 2.85 V; V _{LCD} = 7.0 V; f _{SCLK} = 0; display load = 10 μA	–	24	–	mV/K

Notes

1. The maximum possible V_{LCD} voltage that may be generated is dependent on voltage, temperature and (display) load.
2. Internal clock.
3. RAM contents equal '0'. During power-down, all static currents are switched off.
4. If external V_{LCD}, the display load current is not transmitted to I_{DD}.
5. Tolerance depends on the temperature (typically zero at 27 °C, maximum tolerance values are measured at the temperate range limit).



48 × 84 pixels matrix LCD controller/driver

PCD8544

12 AC CHARACTERISTICS

SYMBOL	PARAMETER	CONDITIONS	MIN.	TYP.	MAX.	UNIT
f _{OSC}	oscillator frequency		20	34	65	kHz
f _{clk(ext)}	external clock frequency		10	32	100	kHz
f _{frame}	frame frequency	f _{OSC} or f _{clk(ext)} = 32 kHz; note 1	–	67	–	Hz
t _{VHRL}	V _{DD} to $\overline{\text{RES}}$ LOW	Fig.16	0 ⁽²⁾	–	30	ms
t _{WL(RES)}	$\overline{\text{RES}}$ LOW pulse width	Fig.16	100	–	–	ns
Serial bus timing characteristics						
f _{SCLK}	clock frequency	V _{DD} = 3.0 V ±10%	0	–	4.00	MHz
T _{cy}	clock cycle SCLK	All signal timing is based on 20% to 80% of V _{DD} and maximum rise and fall times of 10 ns	250	–	–	ns
t _{WH1}	SCLK pulse width HIGH		100	–	–	ns
t _{WL1}	SCLK pulse width LOW		100	–	–	ns
t _{su2}	$\overline{\text{SCE}}$ set-up time		60	–	–	ns
t _{h2}	$\overline{\text{SCE}}$ hold time		100	–	–	ns
t _{WH2}	$\overline{\text{SCE}}$ min. HIGH time		100	–	–	ns
t _{h5}	$\overline{\text{SCE}}$ start hold time; note 3		100	–	–	ns
t _{su3}	D/C set-up time		100	–	–	ns
t _{h3}	D/C hold time		100	–	–	ns
t _{su4}	SDIN set-up time		100	–	–	ns
t _{h4}	SDIN hold time	100	–	–	ns	

Notes

1. $T_{\text{frame}} = \frac{f_{\text{clk(ext)}}}{480}$
2. $\overline{\text{RES}}$ may be LOW before V_{DD} goes HIGH.
3. t_{h5} is the time from the previous SCLK positive edge (irrespective of the state of $\overline{\text{SCE}}$) to the negative edge of $\overline{\text{SCE}}$ (see Fig.15).



48 × 84 pixels matrix LCD controller/driver

PCD8544

12.1 Serial interface

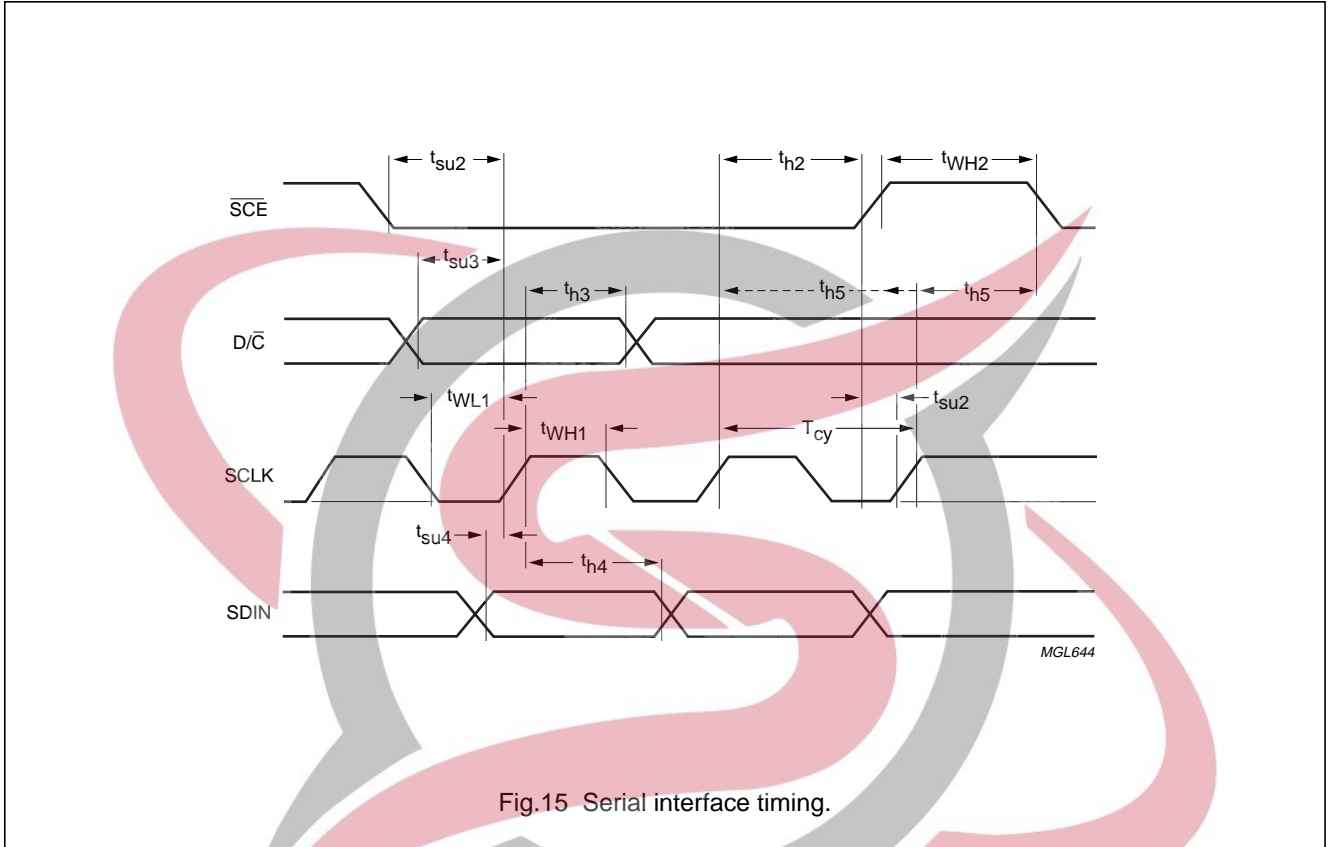

Fig.15 Serial interface timing.

12.2 Reset

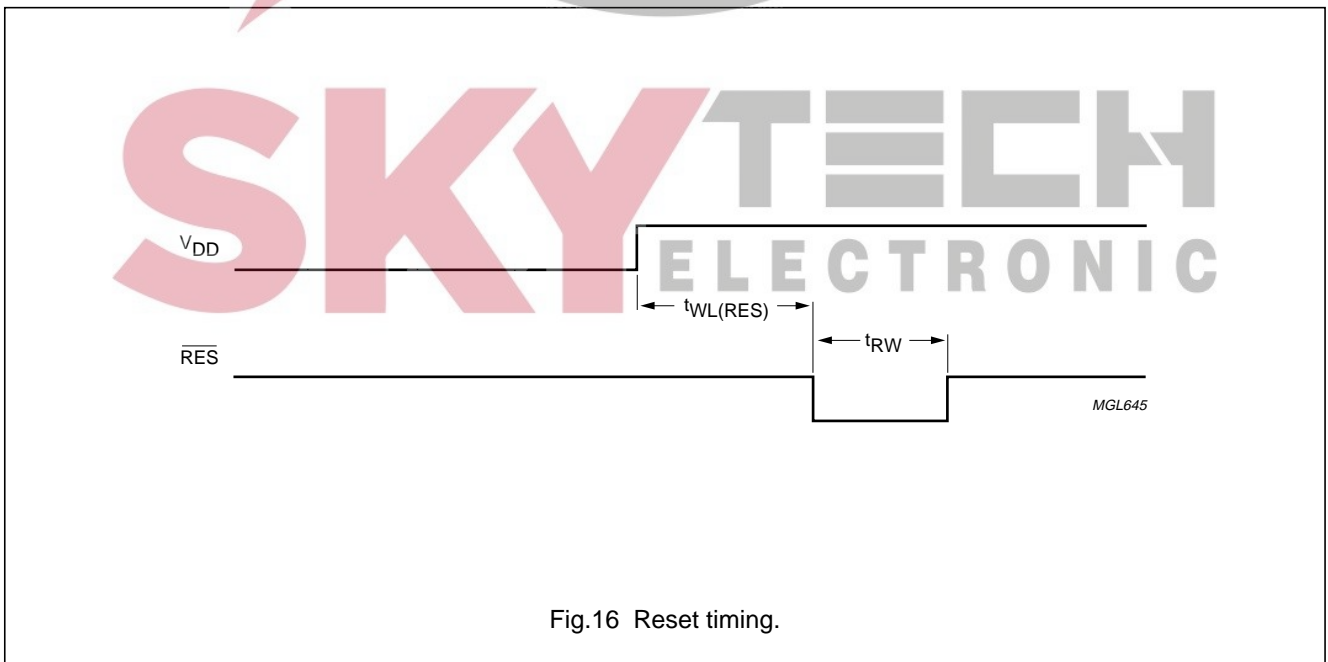

Fig.16 Reset timing.

48 × 84 pixels matrix LCD controller/driver

PCD8544

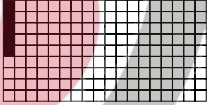
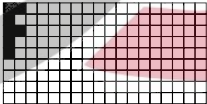
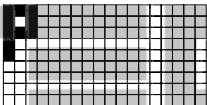
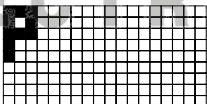
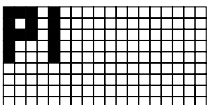

13 APPLICATION INFORMATION

Table 6 Programming example

STEP	SERIAL BUS BYTE									DISPLAY	OPERATION
	D/C	DB7	DB6	DB5	DB4	DB3	DB2	DB1	DB0		
1	start										SCĒ is going LOW
2	0	0	0	1	0	0	0	0	1		function set PD = 0 and V = 0, select extended instruction set (H = 1 mode)
3	0	1	0	0	1	0	0	0	0		set V _{OP} ; V _{OP} is set to a +16 × b [V]
4	0	0	0	1	0	0	0	0	0		function set PD = 0 and V = 0, select normal instruction set (H = 0 mode)
5	0	0	0	0	0	1	1	0	0		display control set normal mode (D = 1 and E = 0)
6	1	0	0	0	1	1	1	1	1		data write Y and X are initialized to 0 by default, so they are not set here
7	1	0	0	0	0	0	1	0	1		data write
8	1	0	0	0	0	0	1	1	1		data write
9	1	0	0	0	0	0	0	0	0		data write
10	1	0	0	0	1	1	1	1	1		data write

48 × 84 pixels matrix LCD controller/driver

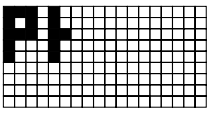
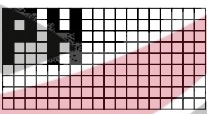
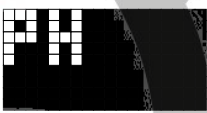
PCD8544

STEP	SERIAL BUS BYTE									DISPLAY	OPERATION
	D/C	DB7	DB6	DB5	DB4	DB3	DB2	DB1	DB0		
11	1	0	0	0	0	0	1	0	0		data write
12	1	0	0	0	1	1	1	1	1		data write
13	0	0	0	0	0	1	1	0	1		display control; set inverse video mode (D = 1 and E = 1)
14	0	1	0	0	0	0	0	0	0		set X address of RAM; set address to '0000000'
15	1	0	0	0	0	0	0	0	0		data write

The pinning is optimized for single plane wiring e.g. for chip-on-glass display modules. Display size: 48 × 84 pixels.

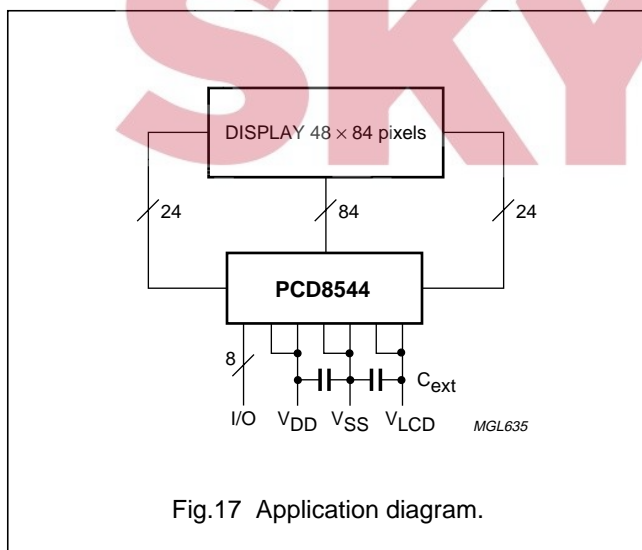

The required minimum value for the external capacitors is: $C_{ext} = 1.0 \mu F$.

Higher capacitor values are recommended for ripple reduction.

14 BONDING PAD LOCATIONS

14.1 Bonding pad information (see Fig.18)

PARAMETER	SIZE
Pad pitch	min. 100 μm
Pad size, aluminium	80 × 100 μm
Bump dimensions	59 × 89 × 17.5 (± 5) μm
Wafer thickness	max. 380 μm

48 × 84 pixels matrix LCD controller/driver

PCD8544

14.2 Bonding pad location

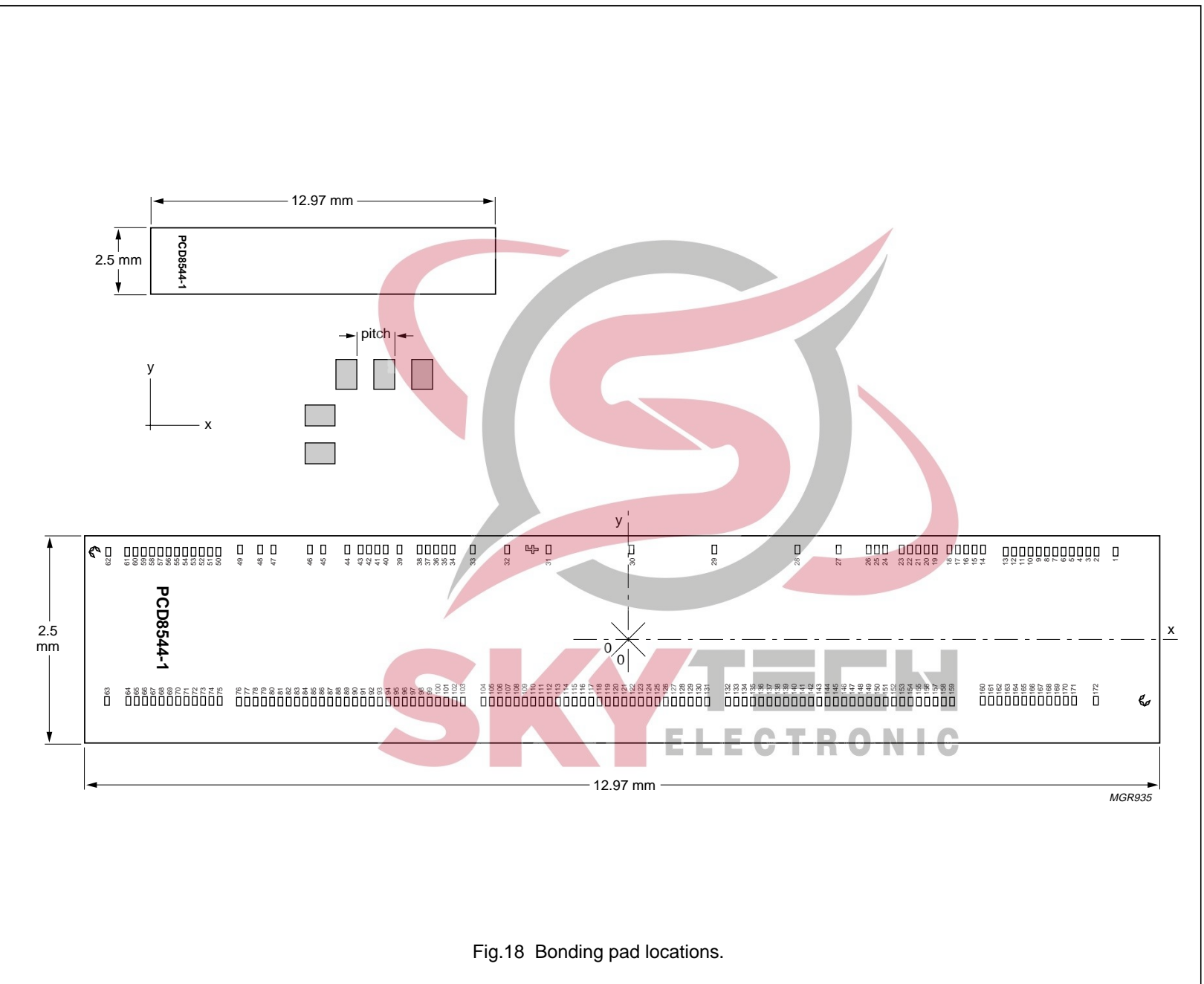

Fig.18 Bonding pad locations.

48 × 84 pixels matrix LCD controller/driver

PCD8544

Table 7 Bonding pad locations (dimensions in μm).
All X/Y coordinates are referenced to the centre
of chip (see Fig.18)

PAD	PAD NAME	x	y	PAD	PAD NAME	x	y
1	dummy1	+5932	+1060	39	T4	-2709	+1085
2	R36	+5704	+1060	40	V _{SS1}	-2876	+1085
3	R37	+5604	+1060	41	V _{SS1}	-2976	+1085
4	R38	+5504	+1060	42	V _{SS1}	-3076	+1085
5	R39	+5404	+1060	43	V _{SS1}	-3176	+1085
6	R40	+5304	+1060	44	T1	-3337	+1085
7	R41	+5204	+1060	45	V _{LCD2}	-3629	+1085
8	R42	+5104	+1060	46	V _{LCD2}	-3789	+1085
9	R43	+5004	+1060	47	V _{LCD1}	-4231	+1085
10	R44	+4904	+1060	48	V _{LCD1}	-4391	+1085
11	R45	+4804	+1060	49	T2	-4633	+1085
12	R46	+4704	+1060	50	R23	-4894	+1060
13	R47	+4604	+1060	51	R22	-4994	+1060
14	V _{DD1}	+4330	+1085	52	R21	-5094	+1060
15	V _{DD1}	+4230	+1085	53	R20	-5194	+1060
16	V _{DD1}	+4130	+1085	54	R19	-5294	+1060
17	V _{DD1}	+4030	+1085	55	R18	-5394	+1060
18	V _{DD1}	+3930	+1085	56	R17	-5494	+1060
19	V _{DD2}	+3750	+1085	57	R16	-5594	+1060
20	V _{DD2}	+3650	+1085	58	R15	-5694	+1060
21	V _{DD2}	+3550	+1085	59	R14	-5794	+1060
22	V _{DD2}	+3450	+1085	60	R13	-5894	+1060
23	V _{DD2}	+3350	+1085	61	R12	-5994	+1060
24	V _{DD2}	+3250	+1085	62	dummy2	-6222	+1060
25	V _{DD2}	+3150	+1085	63	dummy3	-6238	-738
26	V _{DD2}	+3050	+1085	64	R0	-5979	-738
27	SCLK	+2590	+1085	65	R1	-5879	-738
28	SDIN	+2090	+1085	66	R2	-5779	-738
29	D/C	+1090	+1085	67	R3	-5679	-738
30	SCE	+90	+1085	68	R4	-5579	-738
31	RES	-910	+1085	69	R5	-5479	-738
32	OSC	-1410	+1085	70	R6	-5379	-738
33	T3	-1826	+1085	71	R7	-5279	-738
34	V _{SS2}	-2068	+1085	72	R8	-5179	-738
35	V _{SS2}	-2168	+1085	73	R9	-5079	-738
36	V _{SS2}	-2268	+1085	74	R10	-4979	-738
37	V _{SS2}	-2368	+1085	75	R11	-4879	-738
38	V _{SS2}	-2468	+1085	76	C0	-4646	-746

48 × 84 pixels matrix LCD controller/driver

PCD8544

PAD	PAD NAME	x	y
77	C1	-4546	-746
78	C2	-4446	-746
79	C3	-4346	-746
80	C4	-4246	-746
81	C5	-4146	-746
82	C6	-4046	-746
83	C7	-3946	-746
84	C8	-3846	-746
85	C9	-3746	-746
86	C10	-3646	-746
87	C11	-3546	-746
88	C12	-3446	-746
89	C13	-3346	-746
90	C14	-3246	-746
91	C15	-3146	-746
92	C16	-3046	-746
93	C17	-2946	-746
94	C18	-2846	-746
95	C19	-2746	-746
96	C20	-2646	-746
97	C21	-2546	-746
98	C22	-2446	-746
99	C23	-2346	-746
100	C24	-2246	-746
101	C25	-2146	-746
102	C26	-2046	-746
103	C27	-1946	-746
104	C28	-1696	-746
105	C29	-1596	-746
106	C30	-1496	-746
107	C31	-1396	-746
108	C32	-1296	-746
109	C33	-1196	-746
110	C34	-1096	-746
111	C35	-996	-746
112	C36	-896	-746
113	C37	-796	-746
114	C38	-696	-746
115	C39	-596	-746
116	C40	-496	-746
117	C41	-396	-746

PAD	PAD NAME	x	y
118	C42	-296	-746
119	C43	-196	-746
120	C44	-96	-746
121	C45	+4	-746
122	C46	+104	-746
123	C47	+204	-746
124	C48	+304	-746
125	C49	+404	-746
126	C50	+504	-746
127	C51	+604	-746
128	C52	+704	-746
139	C53	+804	-746
130	C54	+904	-746
131	C55	+1004	-746
132	C56	+1254	-746
133	C57	+1354	-746
134	C58	+1454	-746
135	C59	+1554	-746
136	C60	+1654	-746
137	C61	+1754	-746
138	C62	+1854	-746
139	C63	+1954	-746
140	C64	+2054	-746
141	C65	+2154	-746
142	C66	+2254	-746
143	C67	+2354	-746
144	C68	+2454	-746
145	C69	+2554	-746
146	C70	+2654	-746
147	C71	+2754	-746
148	C72	+2854	-746
149	C73	+2954	-746
150	C74	+3054	-746
151	C75	+3154	-746
152	C76	+3254	-746
153	C77	+3354	-746
154	C78	+3454	-746
155	C79	+3554	-746
156	C80	+3654	-746
157	C81	+3754	-746
158	C82	+3854	-746

48 × 84 pixels matrix LCD controller/driver**PCD8544**

PAD	PAD NAME	x	y
159	C83	+3954	-746
160	R35	+4328	-738
161	R34	+4428	-738
162	R33	+4528	-738
163	R32	+4628	-738
164	R31	+4728	-738
165	R30	+4828	-738
166	R29	+4928	-738
167	R28	+5028	-738
168	R27	+5128	-738
169	R26	+5228	-738
170	R25	+5328	-738
171	R24	+5428	-738
172	dummy4	+5694	-738

The logo for SkyTech Electronic features a large, stylized 'S' composed of two overlapping, curved bands in shades of pink and grey. Below this graphic, the word 'SKYTECH' is written in a bold, sans-serif font, with 'SKY' in pink and 'TECH' in grey. Underneath 'SKYTECH', the word 'ELECTRONIC' is written in a smaller, all-caps, grey sans-serif font.

SKYTECH
ELECTRONIC

48 × 84 pixels matrix LCD controller/driver

PCD8544

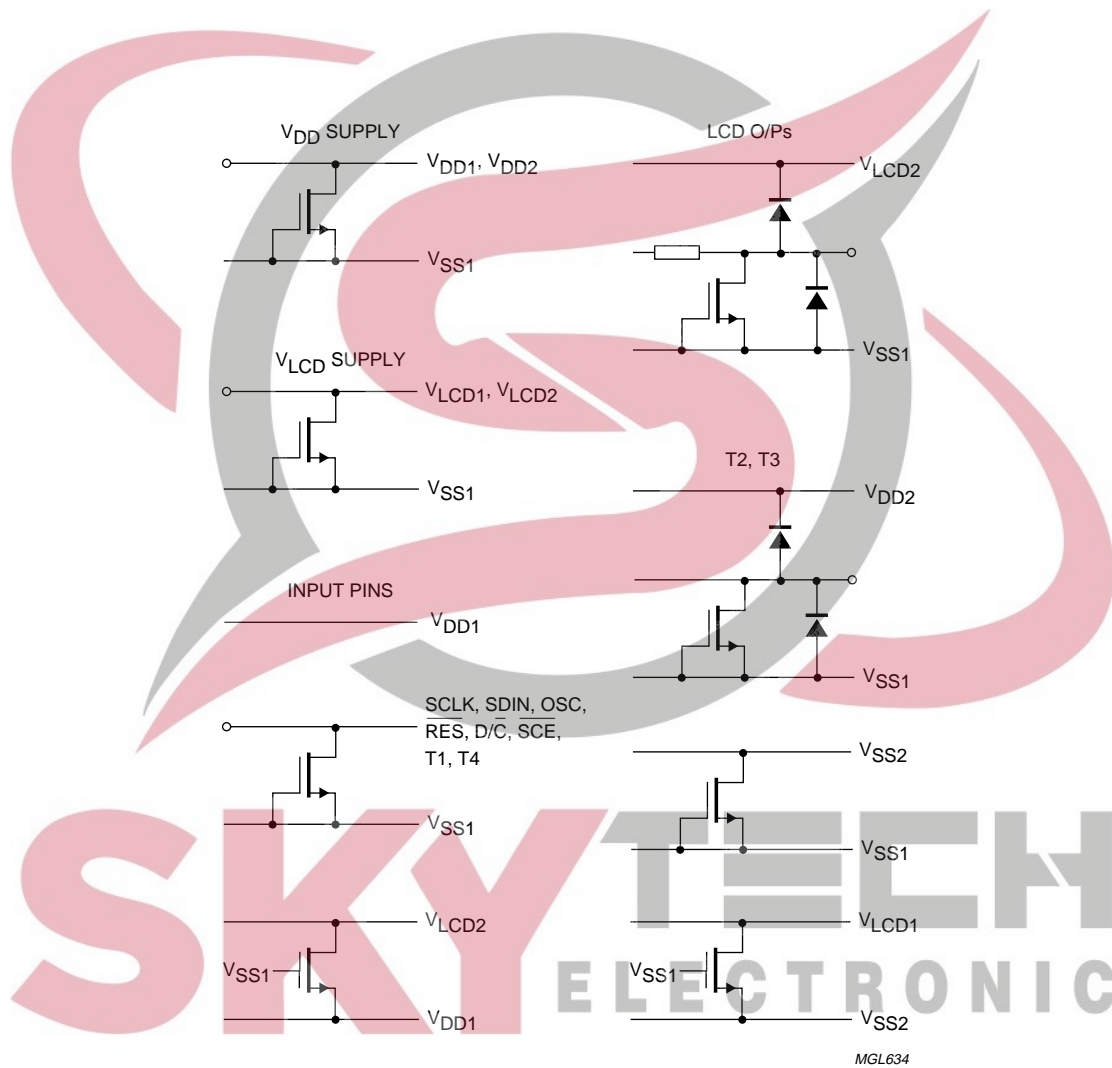

Fig.19 Device protection diagram.

48 × 84 pixels matrix LCD controller/driver

PCD8544

15 TRAY INFORMATION

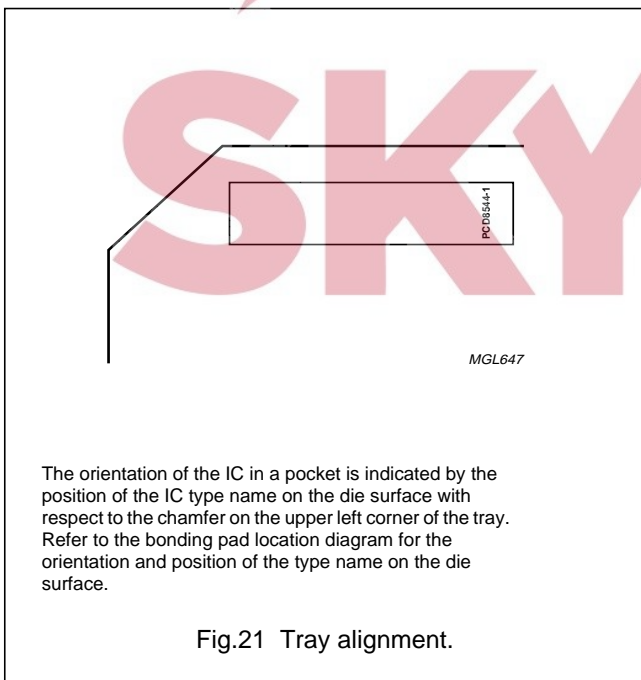
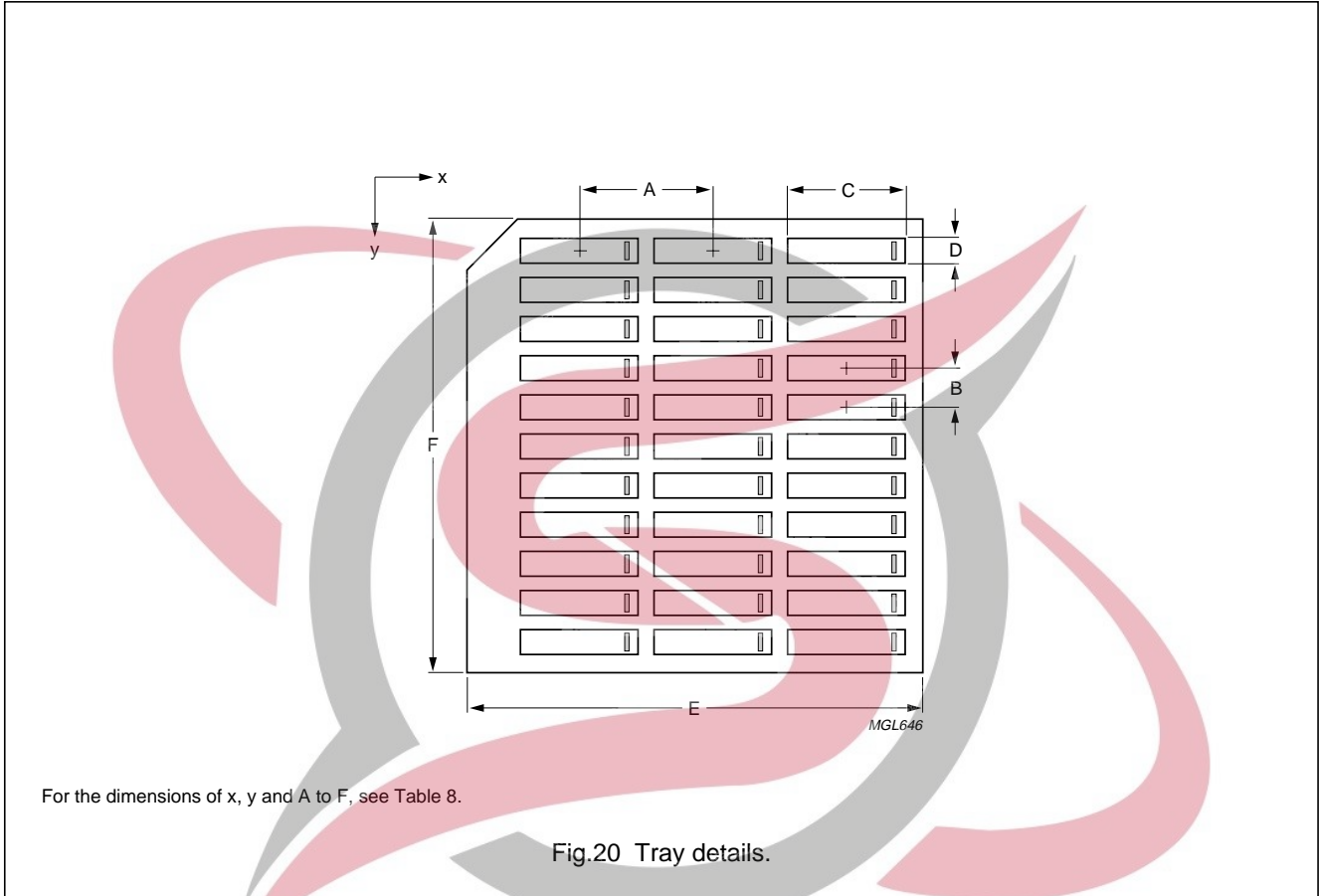

Table 8 Dimensions

DIM.	DESCRIPTION	VALUE
A	pocket pitch, in the x direction	14.82 mm
B	pocket pitch, in the y direction	4.39 mm
C	pocket width, in the x direction	13.27 mm
D	pocket width, in the y direction	2.8 mm
E	tray width, in the x direction	50.67 mm
F	tray width, in the y direction	50.67 mm
x	no. of pockets in the x direction	3
y	no. of pockets in the y direction	11

48 × 84 pixels matrix LCD controller/driver

PCD8544

16 DEFINITIONS

Data sheet status	
Objective specification	This data sheet contains target or goal specifications for product development.
Preliminary specification	This data sheet contains preliminary data; supplementary data may be published later.
Product specification	This data sheet contains final product specifications.
Limiting values	
Limiting values given are in accordance with the Absolute Maximum Rating System (IEC 134). Stress above one or more of the limiting values may cause permanent damage to the device. These are stress ratings only and operation of the device at these or at any other conditions above those given in the Characteristics sections of the specification is not implied. Exposure to limiting values for extended periods may affect device reliability.	
Application information	
Where application information is given, it is advisory and does not form part of the specification.	

17 LIFE SUPPORT APPLICATIONS

These products are not designed for use in life support appliances, devices, or systems where malfunction of these products can reasonably be expected to result in personal injury. Philips customers using or selling these products for use in such applications do so at their own risk and agree to fully indemnify Philips for any damages resulting from such improper use or sale.



48 × 84 pixels matrix LCD controller/driver

PCD8544

NOTES



Philips Semiconductors – a worldwide company

Argentina: see South America

Australia: 34 Waterloo Road, NORTH RYDE, NSW 2113,
Tel. +61 2 9805 4455, Fax. +61 2 9805 4466

Austria: Computerstr. 6, A-1101 WIEN, P.O. Box 213,
Tel. +43 1 60 101 1248, Fax. +43 1 60 101 1210

Belarus: Hotel Minsk Business Center, Bld. 3, r. 1211, Volodarski Str. 6,
220050 MINSK, Tel. +375 172 20 0733, Fax. +375 172 20 0773

Belgium: see The Netherlands

Brazil: see South America

Bulgaria: Philips Bulgaria Ltd., Energoproject, 15th floor,
51 James Bourchier Blvd., 1407 SOFIA,
Tel. +359 2 68 9211, Fax. +359 2 68 9102

Canada: PHILIPS SEMICONDUCTORS/COMPONENTS,
Tel. +1 800 234 7381, Fax. +1 800 943 0087

China/Hong Kong: 501 Hong Kong Industrial Technology Centre,
72 Tat Chee Avenue, Kowloon Tong, HONG KONG,
Tel. +852 2319 7888, Fax. +852 2319 7700

Colombia: see South America

Czech Republic: see Austria

Denmark: Sydhavnsgade 23, 1780 COPENHAGEN V,
Tel. +45 33 29 3333, Fax. +45 33 29 3905

Finland: Sinikalliontie 3, FIN-02630 ESPOO,
Tel. +358 9 615 800, Fax. +358 9 6158 0920

France: 51 Rue Carnot, BP317, 92156 SURESNES Cedex,
Tel. +33 1 4099 6161, Fax. +33 1 4099 6427

Germany: Hammerbrookstraße 69, D-20097 HAMBURG,
Tel. +49 40 2353 60, Fax. +49 40 2353 6300

Hungary: see Austria

India: Philips INDIA Ltd, Band Box Building, 2nd floor,
254-D, Dr. Annie Besant Road, Worli, MUMBAI 400 025,
Tel. +91 22 493 8541, Fax. +91 22 493 0966

Indonesia: PT Philips Development Corporation, Semiconductors Division,
Gedung Philips, Jl. Buncit Raya Kav.99-100, JAKARTA 12510,
Tel. +62 21 794 0040 ext. 2501, Fax. +62 21 794 0080

Ireland: Newstead, Clonskeagh, DUBLIN 14,
Tel. +353 1 7640 000, Fax. +353 1 7640 200

Israel: RAPAC Electronics, 7 Kehilat Saloniki St, PO Box 18053,
TEL AVIV 61180, Tel. +972 3 645 0444, Fax. +972 3 649 1007

Italy: PHILIPS SEMICONDUCTORS, Piazza IV Novembre 3,
20124 MILANO, Tel. +39 2 6752 2531, Fax. +39 2 6752 2557

Japan: Philips Bldg 13-37, Kohnan 2-chome, Minato-ku,
TOKYO 108-8507, Tel. +81 3 3740 5130, Fax. +81 3 3740 5077

Korea: Philips House, 260-199 Itaewon-dong, Yongsan-ku, SEOUL,
Tel. +82 2 709 1412, Fax. +82 2 709 1415

Malaysia: No. 76 Jalan Universiti, 46200 PETALING JAYA, SELANGOR,
Tel. +60 3 750 5214, Fax. +60 3 757 4880

Mexico: 5900 Gateway East, Suite 200, EL PASO, TEXAS 79905,
Tel. +9-5 800 234 7381, Fax +9-5 800 943 0087

Middle East: see Italy

Netherlands: Postbus 90050, 5600 PB EINDHOVEN, Bldg. VB,
Tel. +31 40 27 82785, Fax. +31 40 27 88399

New Zealand: 2 Wagener Place, C.P.O. Box 1041, AUCKLAND,
Tel. +64 9 849 4160, Fax. +64 9 849 7811

Norway: Box 1, Manglerud 0612, OSLO,
Tel. +47 22 74 8000, Fax. +47 22 74 8341

Pakistan: see Singapore

Philippines: Philips Semiconductors Philippines Inc.,
106 Valero St. Salcedo Village, P.O. Box 2108 MCC, MAKATI,
Metro MANILA, Tel. +63 2 816 6380, Fax. +63 2 817 3474

Poland: Ul. Lukiska 10, PL 04-123 WARSZAWA,
Tel. +48 22 612 2831, Fax. +48 22 612 2327

Portugal: see Spain

Romania: see Italy

Russia: Philips Russia, Ul. Usatcheva 35A, 119048 MOSCOW,
Tel. +7 095 755 6918, Fax. +7 095 755 6919

Singapore: Lorong 1, Toa Payoh, SINGAPORE 319762,
Tel. +65 350 2538, Fax. +65 251 6500

Slovakia: see Austria

Slovenia: see Italy

South Africa: S.A. PHILIPS Pty Ltd., 195-215 Main Road Martindale,
2092 JOHANNESBURG, P.O. Box 7430 Johannesburg 2000,
Tel. +27 11 470 5911, Fax. +27 11 470 5494

South America: Al. Vicente Pinzon, 173, 6th floor,
04547-130 SÃO PAULO, SP, Brazil,
Tel. +55 11 821 2333, Fax. +55 11 821 2382

Spain: Balmes 22, 08007 BARCELONA,
Tel. +34 93 301 6312, Fax. +34 93 301 4107

Sweden: Kottbygatan 7, Akalla, S-16485 STOCKHOLM,
Tel. +46 8 5985 2000, Fax. +46 8 5985 2745

Switzerland: Allmendstrasse 140, CH-8027 ZÜRICH,
Tel. +41 1 488 2741 Fax. +41 1 488 3263

Taiwan: Philips Semiconductors, 6F, No. 96, Chien Kuo N. Rd., Sec. 1,
TAIPEI, Taiwan Tel. +886 2 2134 2886, Fax. +886 2 2134 2874

Thailand: PHILIPS ELECTRONICS (THAILAND) Ltd.,
209/2 Sanpavuth-Bangna Road Prakanong, BANGKOK 10260,
Tel. +66 2 745 4090, Fax. +66 2 398 0793

Turkey: Talatpasa Cad. No. 5, 80640 GÜLTEPE/ISTANBUL,
Tel. +90 212 279 2770, Fax. +90 212 282 6707

Ukraine: PHILIPS UKRAINE, 4 Patrice Lumumba str., Building B, Floor 7,
252042 KIEV, Tel. +380 44 264 2776, Fax. +380 44 268 0461

United Kingdom: Philips Semiconductors Ltd., 276 Bath Road, Hayes,
MIDDLESEX UB3 5BX, Tel. +44 181 730 5000, Fax. +44 181 754 8421

United States: 811 East Arques Avenue, SUNNYVALE, CA 94088-3409,
Tel. +1 800 234 7381, Fax. +1 800 943 0087

Uruguay: see South America

Vietnam: see Singapore

Yugoslavia: PHILIPS, Trg N. Pasica 5/v, 11000 BEOGRAD,
Tel. +381 11 62 5344, Fax. +381 11 63 5777

For all other countries apply to: Philips Semiconductors,
International Marketing & Sales Communications, Building BE-p, P.O. Box 218,
5600 MD EINDHOVEN, The Netherlands, Fax. +31 40 27 24825

Internet: <http://www.semiconductors.philips.com>

© Philips Electronics N.V. 1999

SCA63

All rights are reserved. Reproduction in whole or in part is prohibited without the prior written consent of the copyright owner.

The information presented in this document does not form part of any quotation or contract, is believed to be accurate and reliable and may be changed without notice. No liability will be accepted by the publisher for any consequence of its use. Publication thereof does not convey nor imply any license under patent- or other industrial or intellectual property rights.

Printed in The Netherlands

465008/750/01/pp32

Date of release: 1999 Apr 12

Document order number: 9397 750 05024

Let's make things better.

**Philips
Semiconductors**



PHILIPS